

LED Gimbal Light 7"

30W | bis zu 90° schwenkbar | CitizenChip

Bestellnummer: KM-GL030-D7

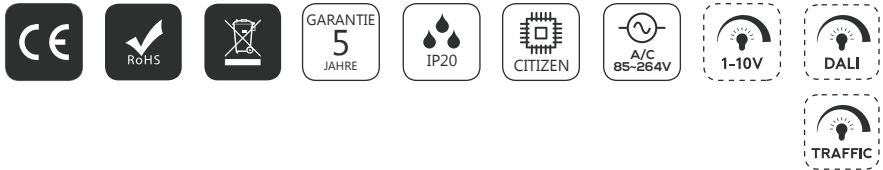

EINSATZGEBIETE

Ideal für Rigipsdecken, Einkaufscenter, POS und vieles mehr.



MASSE

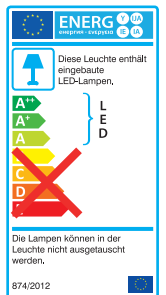
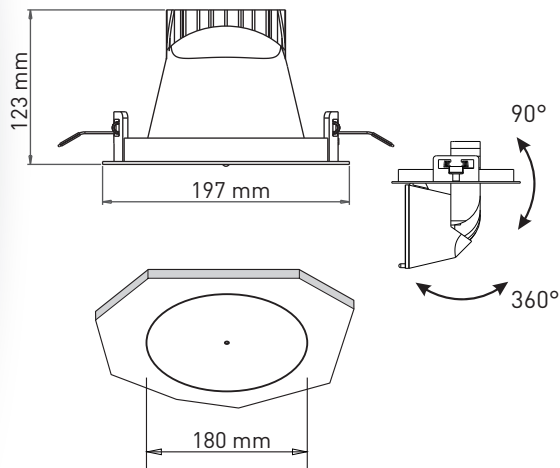

DOWNLIGHTS 

OPTIK UND ELEKTRIK



Nennleistung	30W
Farbtemperatur	3000K/4000K
Lichtstrom	3000(±5%)lm
Effizienz	100(±5%)lm/W
Farbwiedergabe/CRI	>90
Abstrahlwinkel	16° 24° 36°
Optionale Funktionen	Traffic, 1-10V, DALI
LED Lebensdauer	>50.000 Std.



ZUBEHÖR

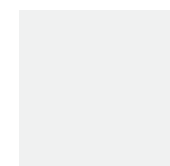
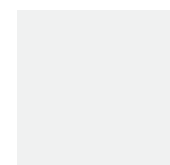
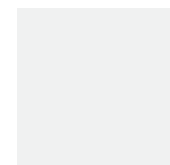
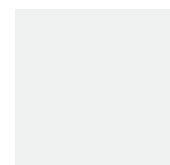
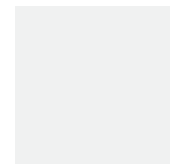

MECHANIK



Betriebstemperatur	-20°C bis +50°C
Maße	Ø197 x 123 mm / 180 mm 
Gewicht	1,5kg
Montage Optionen	Einbau bis zu 90° schwenkbar bis zu 360° drehbar



LIEFERUMFANG

Leuchtkörper, qualitatives Netzteil

LICHTKURVE

