

LED High Street

50W

Zertifiziert ENEC

NichiaChip

Bestellnummer: KM-ST08-050

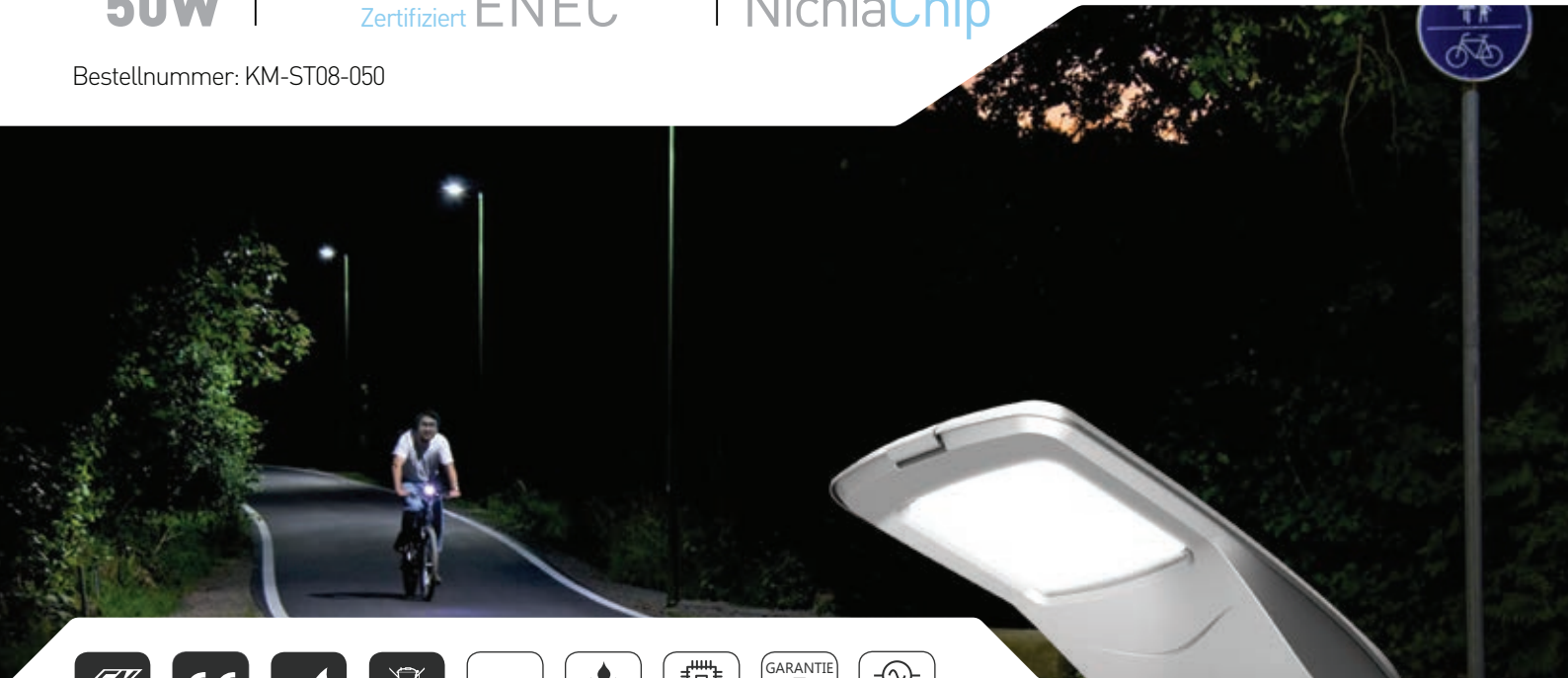

				IK08			GARANTIE 5 JAHRE	

EINSATZGEBIETE

Ideal für Nebenstraßen, Parkplätze und vieles mehr.



MAßE

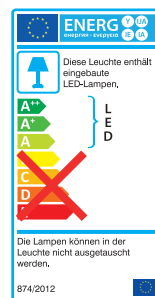
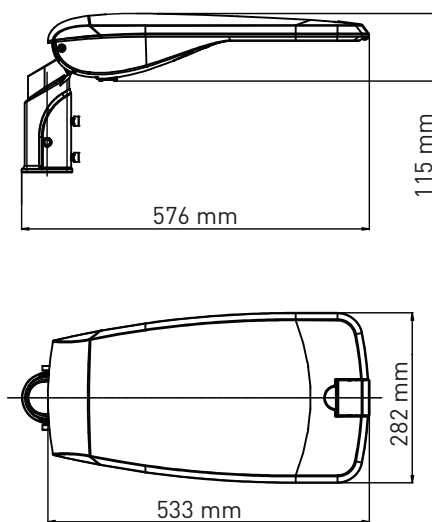

STRAßENLEUCHTEN

OPTIK UND ELEKTRIK



Nennleistung	50W
Farbtemperatur	4000K/5000K
Lichtstrom	6000(±5%)lm
Effizienz	120(±5%)lm/W
Farbwiedergabe/CRI	>80
Abstrahlwinkel	A (R09601) B (R09602) C (R09603)
Optionale Funktionen	DALI, 1-10V, Tageslichtkontrolle, Zeitkontrolle
LED Lebensdauer	>50.000 Std.



ZUBEHÖR



WANDPLATTE für 60mm Adpt.
KM-Z-HWP-060

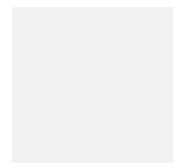
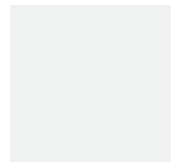
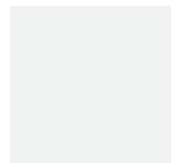
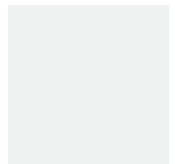

MECHANIK

Betriebstemperatur	-30°C bis +50°C
Maße (HxBxT)	115 x 282 x 576 mm
Gewicht	6,5kg
Montage Optionen	Mast / Wandmontage (Einstellbarer Winkel) Adapterhalterung wählbar: 34/42/60/76 mm



 **LIEFERUMFANG**
Leuchtkörper inklusive qualitativem
Netzteil, Adapterhalterung

LICHTKURVE

